



* JBL Audio equipped vehicles will require additional part # [DP-TYJBL1](#) audio interface.







NOTICE OF INTENDED INSTALLATION AND USE

THE CAR SHOW MULTI-MEDIA NAVIGATION SYSTEMS CONTAIN AN INTERNAL VIDEO PLAYER, WHICH IS NOT INTENDED FOR VIEWING BY THE DRIVER. THE VIDEO PLAYER IS DISABLED WHEN THE VEHICLE IS IN MOTION THROUGH A CONNECTION TO THE PARKING BRAKE.

THE INSTALLER OF THIS PRODUCT MUST INSURE THE VIDEO DISABLE CONNECTION IS WORKING PROPERLY PRIOR TO DELIVERY OF THE VEHICLE.

IMPROPER INSTALLATION COULD DISTRACT THE DRIVER OR INTERFERE WITH SAFE OPERATION OF THE VEHICLE, WHICH COULD RESULT IN SERIOUS INJURY OR DEATH, AND COULD ALSO VIOLATE STATE AND/OR FEDERAL LAW.

CAR SHOW DISCLAIMS ANY LIABILITY FOR ANY BODILY INJURY OR PROPERTY DAMAGE THAT MAY RESULT FROM ANY IMPROPER OR UNINTENDED INSTALLATION AND/OR USE.

	<p style="text-align: center;"><u>STOP</u></p> <p style="text-align: center;">Damage to the vehicle may occur Do not proceed until process has been completed</p>
	<p style="text-align: center;"><u>CAUTION</u></p> <p style="text-align: center;">Process must be carefully observed in order to reduce the risk of damage to the accessory or vehicle</p>
	<p style="text-align: center;"><u>CRITICAL</u></p> <p style="text-align: center;">Process must be carefully observed in order to ensure a quality installation</p>
	<p style="text-align: center;"><u>TOOLS and EQUIPMENT</u></p> <p style="text-align: center;">Specific tools and equipment recommended for this process</p>
	<p style="text-align: center;"><u>SAFETY RISK</u></p> <p style="text-align: center;">Observe safe practices, this process can be dangerous and there is a risk of personal injury</p>
	<p style="text-align: center;"><u>TESTING and TROUBLESHOOTING</u></p> <p style="text-align: center;">Content specific testing and troubleshooting points</p>

Car Show Installation Guide

PREPARING FOR THE INSTALLATION

Before you start, please read these critical steps below

STEP 1

**BEFORE YOU START THE INSTALLATION,
READ THIS GUIDE!**



CHECK THE BATTERY

Test the battery voltage to make sure it's fully charged to a minimum of 12.8 VDC

This only takes seconds and can save hours of troubleshooting later.

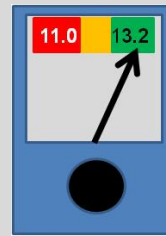

TURN THE VEHICLE

OFF

Keep the Vehicle Off during the installation to avoid setting various Vehicle Fault sensors

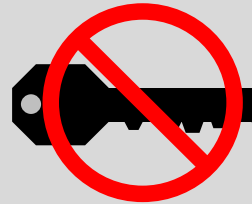

Keep the Vehicle OFF during the installation

Failure to follow this may cause the AIRBAG FAULT SENSOR to become enabled. Dealer Service Departments charge a significant fee to reset the Fault Sensor.



Car Show Installation Guide

REMOVE THE FACTORY RADIO

*JBL Audio equipped vehicles will require additional part # [DP-TYJBL1](#) audio interface

You will need to remove multiple interior trim components prior to removing the factory radio.
The following steps will help guide you through this process.

STEP 2

Carefully Remove Lower Dash Trim Components

Use Caution, the plastic is fragile and excess force can break or damage trim



Carefully Remove Lower Dash Trim Components

Use Caution, the plastic is fragile and excess force can break or damage trim.



Remove Upper Vent Trim

Use thin pry tool to carefully remove vent trim



Unplug Electrical Connections

Carefully unplug harness from back of vent assembly











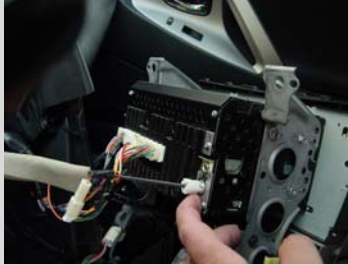

Remove mounting screws

Remove 4 x 10mm bolts to remove radio



Car Show Installation Guide

<p>Unplug Electrical Connections</p> <p>Carefully remove all harnesses from rear of OEM radio</p> <p>*JBL Audio equipped vehicles will require additional part # <u>DP-TYJBL1</u> audio interface</p>		
<p>Remove Factory Brackets/Clips</p> <p>Remove factory brackets and clips from OEM radio (8 x 10mm bolts 4 Left/4 Right)</p>		
<p>Re-Install Factory Brackets/Clips on Car Show Unit</p> <p>Re-install factory brackets/clips on Car Show unit (8 x 10mm bolts 4 Left/4 Right)</p>		

<p>LOCATING REMOTE COMPONENTS</p> <p>You will need to mount the GPS and Optional Satellite Radio Antennas on the exterior of the vehicle. And mount the iPod Interface Connector in the vehicle. The following steps will help guide you through this process.</p>		<p>STEP 3</p>
<p>Use Caution around SRS Components</p> <p>It is the <u>installer's responsibility</u> to ensure that the safety equipment in the vehicle is NOT adversely affected by installation of this system. Ensure that the routing of the harnesses do NOT obstruct airbags, SRS or other safety devices.</p>		
<p>Mount the GPS and Sat Radio antenna in a location on the exterior of the Vehicle</p> <p>Route the GPS harness away from other power harnesses in the vehicle.</p> <p>This will help to ensure optimum performance of the GPS system.</p>		

Car Show Installation Guide

“OPTIONAL”

Install the iPod interface connector in a location accessible to the end-user

Locate the iPod interface module in an area which can be serviced in the future.

The iPod cable is intended to be a serviceable item, which plugs into the iPod/Sat radio Interface Module.



INSTALL THE CAR SHOW NAVIGATION SYSTEM

You will need to prepare the Car Show Navigation System for installation in the vehicle.

STEP 4

Remove the DVD Transport Screws

There are 2 x Phillips Transport Screws which protect the DVD Mechanism during transportation.

Transport Screws must be removed prior to installation.

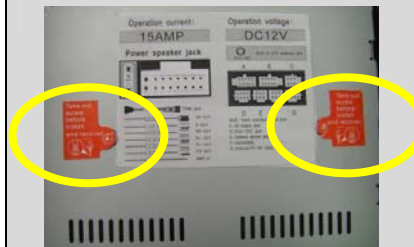

Connect the Power and GPS Harnesses

The GPS Harness must be tightened with a WRENCH to ensure it is properly seated.

Be sure to use white cable clamp to secure GPS antenna cable

Failure to follow this step may result in poor GPS signal



Connect Optional Harnesses such as iPod, Satellite Radio, Camera, Reverse Sensors

These harnesses must be fully engaged prior to the system installation.

See the Harness Diagrams for more information

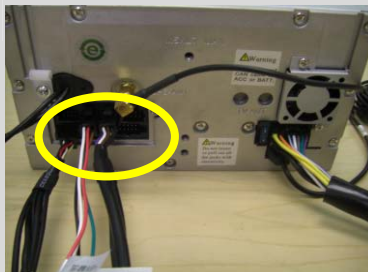









Prepare the Vehicle side harnesses for connection to the Car Show Harness



Use care not to pinch or damage cables as this will cause performance issues/failures



Car Show Installation Guide

<p>Mount Car Show Navigation into Dash</p> <p>Be sure to fully engage all connectors Insert Car Show Navigation System Into Dash and mount using OEM 4 x 10mm (2 Left/2 Right) screws Re-install upper vent assembly and be sure to connect all harnesses</p>		
<p>Re-Install Lower Trim Components</p> <p>Carefully re-install lower dash components</p>		
<p>Verify Unit Operation</p> <p>Power on unit to verify full operation</p>		
<p>Insert a DVD to confirm the Video Disable Circuit is properly Operating.</p> <p>The Brake Wire must be connected to the Park Brake Indicator Wire to complete a ground when the brake is engaged.</p>		

<h2 style="margin: 0;">ENABLE INSTALLER SETTINGS</h2> <p style="margin: 5px 0 0 20px;">You will need to select certain Installer Setting based on any Optional Equipment that you may have installed</p>	<h1 style="margin: 0;">STEP</h1> <h1 style="margin: 0;">5</h1>
--	--

<p>Launch the Installer Setting Screen</p> <p>From any screen with the Menu Button, follow these steps to display the Installer Setting Screen, select:</p> <ol style="list-style-type: none"> 1) From any Screen, select "Menu" 2) From the Menu Screen, select "Settings" 3) Press "Keypad," Press "7253" and "Enter" 		
---	--	---

Car Show Installation Guide

Select the individual Settings as needed for the installed components

Selectable options vary by product and installation. Select the options as applicable for the installed optional components.



Perform Pre-Delivery Tests

You will need to perform several Pre-Delivery Tests to ensure customer satisfaction
Some optional equipment may not be applicable

STEP 6

Turn the vehicle ON and System ON

Confirm the unit starts up properly

Troubleshooting

- 1) Reset the System while the Vehicle is ON
- 2) Confirm all connectors are properly installed
- 3) Check the Vehicle and System Fuses



Select RADIO as the Source

Confirm that the AM and FM reception are as expected

Troubleshooting

- 1) Confirm Antenna is properly connected.
- 2) Reset the System



Select SATELLITE RADIO as the Source

Confirm Channel 001 is present after ~5 minutes

Troubleshooting

- 1) Confirm the SAT Radio is Turned ON in the Installer Settings
- 2) Confirm the antenna has unobstructed view of the Sky
- 3) Confirm the antenna is located on the outside of the vehicle



Select IPOD as the Source





Confirm iPod is communicating and playback is OK

Troubleshooting

- 1) Confirm iPod Version Compatibility – not all are compatible
- 2) Confirm the harnesses are properly engaged
- 3) Reset the System

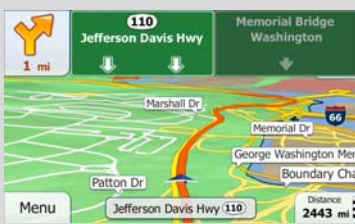

Car Show Installation Guide

<p>Select CD as the Source Confirm CD audio playback is OK</p> <p><u>Troubleshooting</u></p> <ol style="list-style-type: none"> 1) Confirm the Disc is Store Bought and in good condition 2) Reset the system 		
<p>Select DVD as the Source Confirm DVD video playback is OK</p> <p><u>Troubleshooting</u></p> <ol style="list-style-type: none"> 1) Ensure the Park Brake is set to view video 2) Confirm the Disc is Store Bought and in good condition 3) Reset the system 		
<p>Select MP3 as the Source Confirm MP3 playback is OK – Select Favorites</p> <p><u>Troubleshooting</u></p> <ol style="list-style-type: none"> 1) Confirm that a Test Track exists in the Favorites Folder 2) Reset the system 		
<p>Select Phone as the Source Confirm Phone Pairing is successful</p> <p><u>Troubleshooting</u></p> <ol style="list-style-type: none"> 1) Confirm the Phone has BT and is in discoverable mode 2) Confirm the Phone is compatible with the system 3) Reset the system 		
<p>Select NAV as the Source Confirm the Navigation loads and signal strength is OK</p> <p><u>Troubleshooting</u></p> <ol style="list-style-type: none"> 1) Confirm the antenna has an unobstructed view of the sky 2) Confirm the antenna is located on the outside of the vehicle 3) Confirm the antenna connection is properly tightened 		
<p>Select Reverse Camera Confirm the backup camera screen shows in reverse</p> <p><u>Troubleshooting</u></p> <ol style="list-style-type: none"> 1) Confirm the Camera is set to ON in the Installer Settings 2) Confirm the Reverse Trigger wire is attached properly 3) Confirm the Camera is receiving 12VDC as required 		

Car Show Installation Guide

Main Harness Diagram

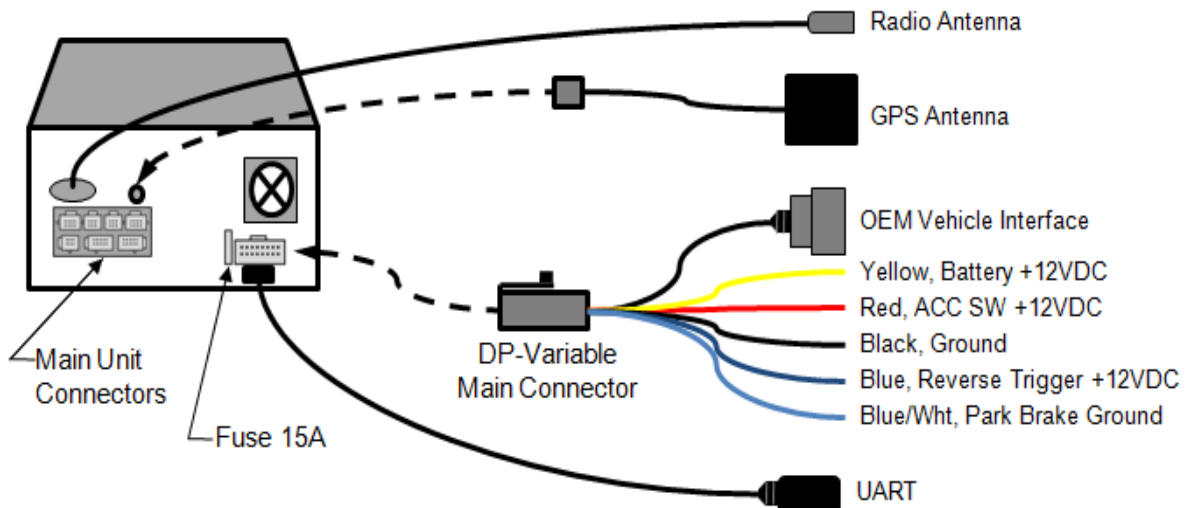

Optional Harness Diagram

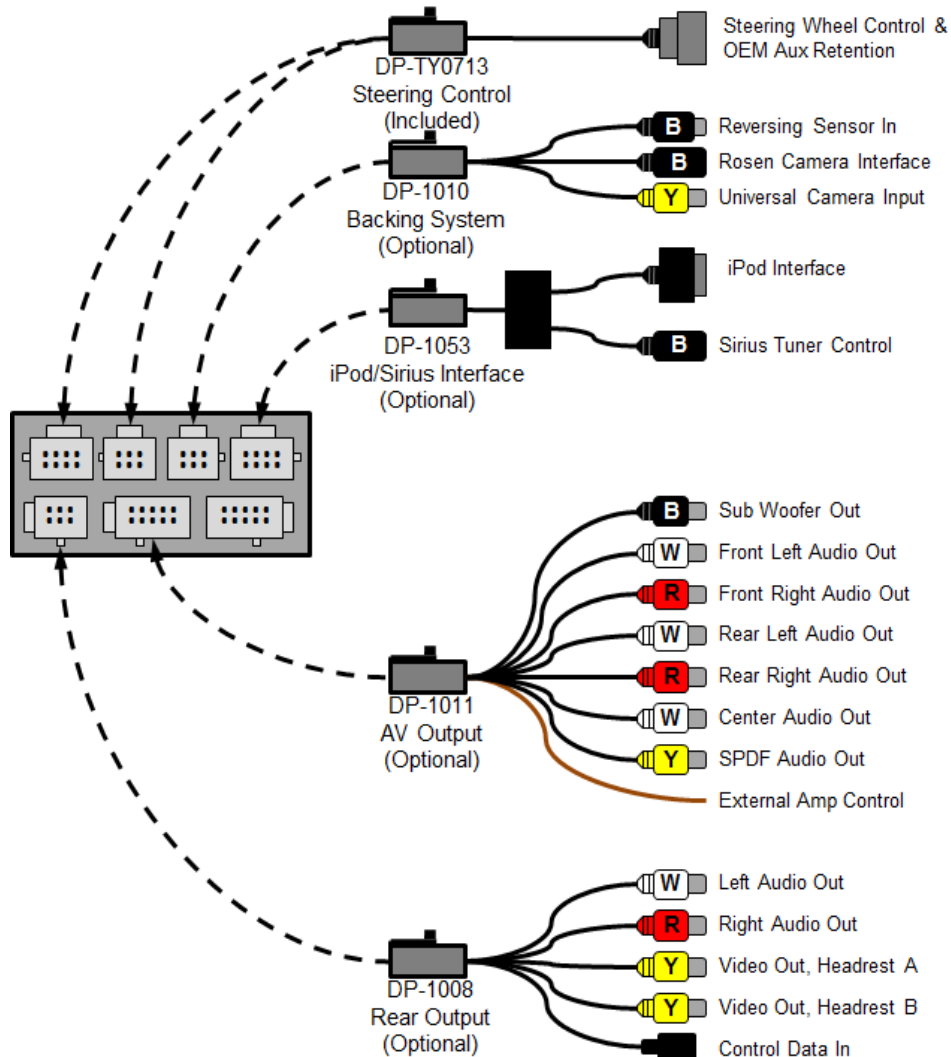

Car Show Installation Guide

